



HANNSpree

HL162CPB (HSG1444)
LCD Monitor

User's Manual

HANNSpree
www.hannspree.eu

Before operating the monitor, please read this manual thoroughly. This manual should be retained for future reference.



This device complies with requirement of EMC directive 2014/30/EU with regard to Electromagnetic Compatibility, and 2014/35/EU and 93/68/EEC with regard to Low Voltage directive.

Socket-outlet shall be near the equipment and shall be accessible.

Trademark Notice:



HANNspree products incorporate High-Definition Multimedia Interface (HDMI™) technology.

The terms HDMI and HDMI High-Definition Multimedia Interface, and the HDMI Logo are trademarks or registered trademarks of HDMI Licensing LLC in the United States and other countries.

RECYCLING INFORMATION

We, at **HANNspree** care very much about our environment protection strategy and firmly believe that it helps us have healthier earth via appropriate treatment and recycling of industrial technology devices at the end-of-life.

These devices contain recyclable materials, which can be re-decomposed and re-integrated into brand-new marvels. On the contrary, other material can be classified to hazardous and poisoned substances. We strongly encourage you to contact the provided information to recycle this product.

For more information, please visit
<http://www.hannspree.eu/>

TABLE OF CONTENTS

SAFETY NOTICE	5
SPECIAL NOTES ON LCD MONITORS	6
FEATURES.....	7
CHECKING THE CONTENTS OF THE PACKAGE	7
SUPPORT HOLSTER STENTS	8
POWER.....	8
MAKING CONNECTIONS.....	9
OPERATING INSTRUCTIONS	10
GENERAL INSTRUCTIONS.....	10
FRONT PANEL CONTROL	11
HOW TO ADJUST A SETTINGS	12
TECHNICAL SUPPORT (FAQ)	15
Q & A FOR GENERAL PROBLEMS	15
ERROR MESSAGE & POSSIBLE SOLUTIONS	17
APPENDIX	19
SPECIFICATIONS.....	19

SAFETY NOTICE

1. The changes or modifications not expressly approved by the party responsible for compliance could void the user's authority to operate the equipment.
2. Shielded interface cables and AC power cord, if any, must be used in order to comply with the emission limits.
3. The manufacturer is not responsible for any radio or TV interference caused by unauthorized modification to this equipment. It is the responsibilities of the user to correct such interference.
4. Only use attachments/accessories specified by the manufacturer.

WARNING:

To prevent fire or shock hazard, do not expose the monitor to rain or moisture. Dangerously high voltages are present inside the monitor. Do not open the cabinet. Refer servicing to qualified personnel only.

PRECAUTIONS

- Do not use the monitor near water, e.g. near a bathtub, washbowl, kitchen sink, laundry tub, swimming pool or in a wet basement.
- Do not place the monitor on an unstable cart, stand, or table. If the monitor falls, it can injure a person and cause serious damage to the appliance. Use only a cart or stand recommended by the manufacturer or sold with the monitor. If you mount the monitor on a wall or shelf, use a mounting kit approved by the manufacturer and follow the kit instructions.
- Slots and openings in the back and bottom of the cabinet are provided for ventilation. To ensure reliable operation of the monitor and to protect it from overheating, be sure these openings are not blocked or covered. Do not place the monitor on a bed, sofa, rug, or similar surface. Do not place the monitor near or over a radiator or heat register. Do not place the monitor in a bookcase or cabinet unless proper ventilation is provided.
- The monitor should be operated only from the type of power source indicated on the label. If you are not sure of the type of power supplied to your home, consult your dealer or local power company.
- Unplug the unit during a lightning storm or when it will not be used for long period of time. This will protect the monitor from damage due to power surges.
- Do not overload power strips and extension cords. Overloading can result in fire or electric shock.
- Never push any object into the slot on the monitor cabinet. It could short circuit parts causing a fire or electric shock. Never spill liquids on the monitor.
- Do not attempt to service the monitor by yourself; opening or removing covers can expose you to dangerous voltages and other hazards. Please refer all servicing to qualified service personnel.
- The wall socket shall be installed near the equipment and shall be easily accessible.

SPECIAL NOTES ON LCD MONITORS

The following symptoms are normal with LCD monitor and do not indicate a problem.

- Due to the nature of the fluorescent light, the screen may flicker during initial use. Turn off the Power Switch and then turn it on again to make sure the flicker disappears.
- You may find slightly uneven brightness on the screen depending on the desktop pattern you use.
- The LCD screen has effective pixels of 99.99% or more. It may include blemishes of 0.01% or less such as a missing pixel or a pixel lit all of the time.
- Due to the nature of the LCD screen, an afterimage of the previous screen may remain after switching the image, when the same image is displayed for hours. In this case, the screen is recovered slowly by changing the image or turning off the Power Switch for hours.
- If the screen suddenly flashes erratically or the backlighting fails, please contact your dealer or service center for repair. Do not attempt to repair the monitor yourself.

BEFORE YOU OPERATE THE MONITOR

FEATURES

- 39,62cm / 15.6" Wide Screen TFT Color LCD Monitor
- Crisp, Clear Display
- Ergonomic Design
- Space Saving, Compact Case Design

CHECKING THE CONTENTS OF THE PACKAGE

The product package should include the following items:

LCD Monitor

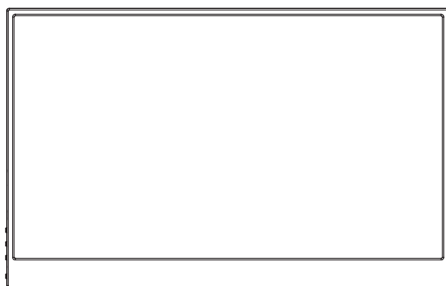

Monitor

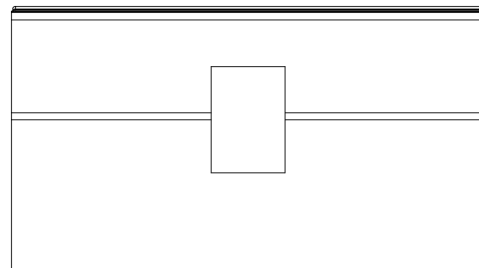

Protective Cover

Cables and User manual

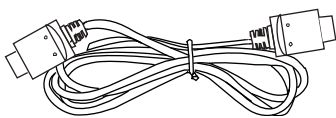

Type-C Cable

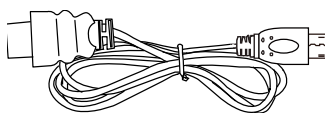

HDMI to Mini HDMI Cable

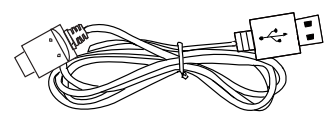

Type-A to Type-C Cable



Warranty Card



Quick Start Guide

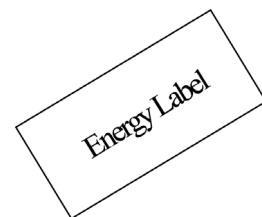

Energy Label

SUPPORT HOLSTER STENTS

INSTALL

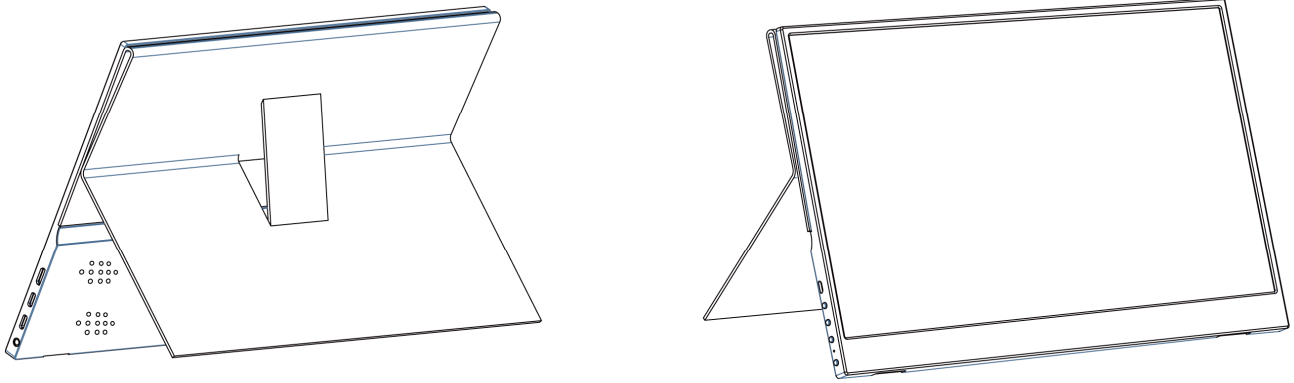

(For reference only)

POWER

POWER SOURCE:

charge a connected notebook. If the included power adapter is connected to the monitor, then the monitor can.

Note: Power Delivery Output : DC 5V 2A

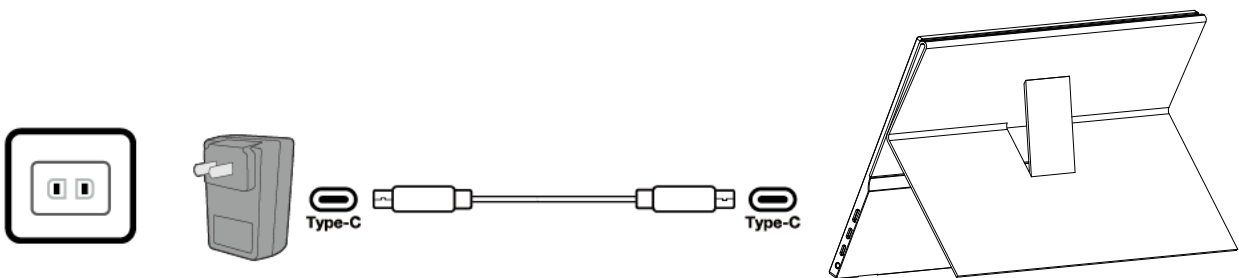

MAKING CONNECTIONS

CONNECTING TO A PC

You can setup your monitor with the below suggested connections. Ensure your monitor is off during this process.

1. Connect one end of the Type-C cable to the back of the monitor and connect the other end to the computer's Type-C port.
2. Connect one end of the Type-C cable to the back of the monitor and connect the other end to the Power Adaptor.
3. Connect one end of the HDMI cable (optional) to the back of the monitor and connect the other end to the computer's HDMI port.
4. Connect the audio cable between the monitor's audio input and the PC's audio output (green port).
5. Turn on your monitor and computer.

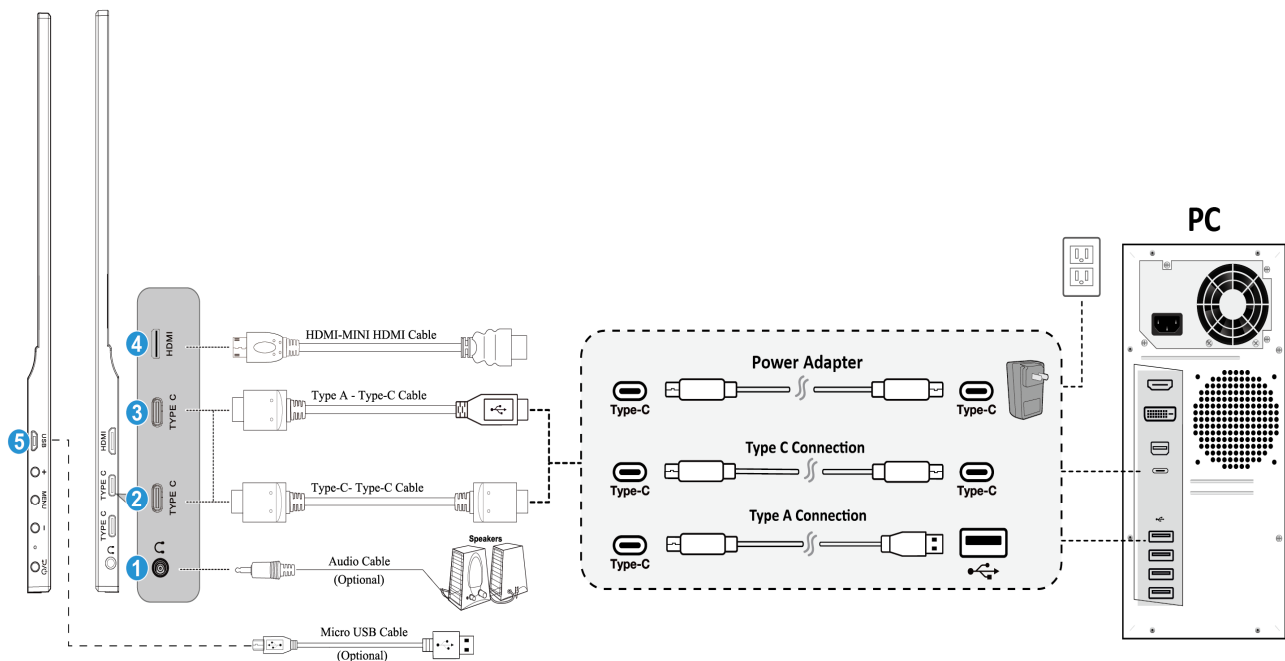

1	Earphone	2	Type-C
3	Type-C	4	Mini HDMI
5	Micro-USB		

OPERATING INSTRUCTIONS

GENERAL INSTRUCTIONS

Press the power button to turn the monitor on or off. The other control buttons are located on the front panel of the monitor. By changing these settings, the picture can be adjusted to your personal preferences.

- The power cord should be connected.
- Connect the Signal cable from the monitor to the HDMI card.
- Press the power button to turn on the monitor. The power indicator will light up.

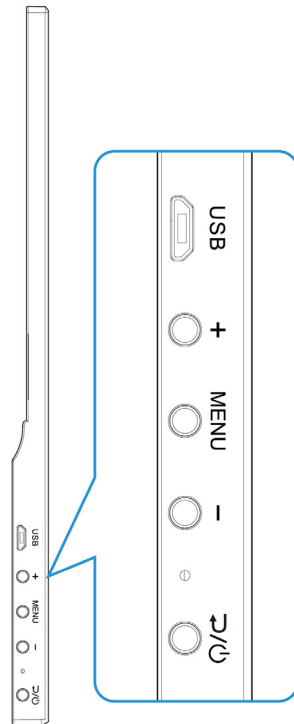

▲ [+]
Brightness adjustment button.



MENU / ENTER



▼ [-]
Volume adjustment button.



Return/Source/Power Button(Press Hold on 3S)

FRONT PANEL CONTROL

- **Power Button:**

1. Press this button to switch ON of monitor power , Press 3S switch OFF of monitor power.
2. When the monitor is working, Press [Power Button] to enter the source selections.
3. When opening the OSD menu, Press [Power Button] to Return.

- **Power Indicator:**

- Blue — Power On mode.
- Red — Power Saving mode.

- **MENU / ENTER:**

Turn the OSD menu on or Enter to the next menu..

- **Adjust + -:**

1. Adjust Brightness and volume when the OSD is off.
2. Navigate through adjustment icons when OSD is ON or adjust a function when function is activated.

NOTES:

- Do not install the monitor in a location near heat sources such as radiators or air ducts, or in a place subject to direct sunlight, or excessive dust or mechanical vibration or shock.
- Save the original shipping box and packing materials, as they will come in handy if you ever have to ship your monitor.
- To keep the monitor looking new, periodically clean it with a soft cloth. Stubborn stains may be removed with a cloth lightly dampened with a mild detergent solution. Never use strong solvents such as thinner, benzene, or abrasive cleaners, since these will damage the cabinet. As a safety precaution, always unplug the monitor before cleaning it.

HOW TO ADJUST A SETTINGS

BRIGHTNESS/ CONTRAST	
BRIGHTNESS	Adjust the brightness value of the display according to your preference. Select 「 BRIGHTNESS 」 option to adjust the brightness value.
CONTRAST	Adjust the contrast value of the display according to your preference. Select 「 CONTRAST 」 option to adjust the contrast value.
ACTIVE CONTRAST	Optimal setting for high contrast images or videos. The dark and light areas of the image are automatically detected, and the contrast is enhanced to provide a clearer, sharper image. Also, you may select the 「 ACTIVE CONTRAST 」 option.
PRESET MODE	Select the preset mode according to your preference: PC/ MOVIE/ GAME/ ECO [The availability of this function depends upon the selected model]
RESPONSE TIME	Setup the display response time through the Response time function. Available settings are MINIMUM , INTERMEDIATE , and MAXIMUM . [This feature is limited to specific models only.]
IMAGE SETTING	
IMAGE RATIO	Setup the image ratio of screen through the aspect ratio function. Available settings are Wide Screen / 4:3
SHARPNESS	Select the 「 SHARPNESS 」 option to adjust the sharpness of the display.
COLOR SETTING	
WARM NATURE (6500K) COOL	Adjust the color temperature value of the display according to your preference: WARM /NATURE/ COOL.
USER	Move the cursor to the User option and select it, 1. To adjust the red, enter the 「 R 」 option and adjust the level. 2. To adjust the green, enter the 「 G 」 option and adjust the level. 3. To adjust the blue, enter the 「 B 」 option and adjust the level.
LOW BLUE LIGHT	Select the 「 Low Blue Light 」 option to adjust the low blue light of the display.
OSD SETTING	

LANGUAGE	Select 「LANGUAGE」 option to change the language of the OSD. Enter the option and select a language.
TRANSPARENCY	Select 「TRANSPARENCY」 option to adjust the transparency of the OSD. Enter the option and adjust the level.
H-POSITION	Select 「H-POSITION」 option to adjust the horizontal position of the OSD. Enter the option and adjust the level.
V-POSITION	Select 「V-POSITION」 option to adjust the vertical position of the OSD. Enter the option and adjust the level.
TIME OUT	Select 「Time Out」 option to set the OSD time out from 5 to 100 seconds. Enter the option and adjust the level.
RESET	
RESET	Select the 「RESET」 option to reset to the monitor's default setting. This will erase the current settings.
EXTRA	
INPUT SELECT	From the Signal Selection menu, select the 「INPUT SELECT」 option to activate the automatic signal search function.
VOLUME	Select the 「VOLUME」 option to change the volume level. Enter the option and adjust the level. [This function applies only to models with incorporated audio.] ● By high volume, risk of hearing damage exists.
MUTE	Select the 「MUTE」 option to switch the function On or Off.
DDC/CI	Select the 「DDC/CI」 option to switch the function On or Off.

Plug & Play DDC2B Feature

This monitor is equipped with VESA DDC2B capabilities according to the VESA DDC STANDARD. It allows the monitor to inform the host system of its identity and, depending on the level of DDC used, communicate additional information about its display capabilities. The DDC2B is a bidirectional data channel based on the I²C protocol. The host can request EDID information over the DDC2B channel.

THIS MONITOR WILL APPEAR TO BE NON-FUNCTIONAL IF THERE IS NO VIDEO INPUT SIGNAL. IN ORDER FOR THIS MONITOR TO OPERATE PROPERLY, THERE MUST BE A VIDEO INPUT SIGNAL.

TECHNICAL SUPPORT (FAQ)

Q & A FOR GENERAL PROBLEMS

PROBLEM & QUESTION	POSSIBLE SOLUTION
Power LED is not on	<ul style="list-style-type: none"> *Check if the Power Switch is in the ON position. *Power Cord should be connected.
No Plug & Play	<ul style="list-style-type: none"> *Check if the PC system is Plug & Play compatible. *Check if the Video Card is Plug & Play compatible. *Check if any plug pins on the HDMI connector are bent.
The display is too dark or too bright.	*Adjust the Contrast and Brightness Controls.
Picture bounces or a wave pattern is present in the picture	*Move electrical devices that may cause electrical interference.
The power LED is ON (Blue) but there's no video or no picture.	<ul style="list-style-type: none"> *Computer Power Switch should be in the ON position. *Computer Video Card should be snugly seated in its slot. *Make sure monitor's video cable is properly connected to the computer. *Inspect monitor's video cable and make sure none of the pins are bent. *Make sure computer is operational by hitting the CAPS LOCK key on the keyboard while observing the CAPS LOCK LED. The LED should either turn ON or OFF after hitting the CAPS LOCK key.
Missing one of the primary colors (RED, GREEN, or BLUE)	*Inspect the monitor's video cable and make sure that none of the pins are bent.
Screen image is not centered or sized properly.	* Adjust pixel frequency CLOCK and PHASE or press hot-key .
Picture has color defects (White does not look white)	*Adjust RGB color or select color temperature.
The screen resolution needs to be adjusted	*Use Windows 7/ Windows 8 / Windows 10 Right click anywhere on desktop and select Properties>Settings>Screen Resolution . Use the silder to adjust the reslution and click Apply .
No sound is outputted from monitor's built-in speaker	<ul style="list-style-type: none"> *Make sure the sound volume adjustment can be clearly identified. *Make sure the System > Silence option in the monitor menu is on.

Addendum related to Windows 7 / Windows 8 / Windows 10

When you encounter display problem under Windows 7/ Windows 8 / Windows 10, you need to do the following:

1. Make sure your PC computer (Hardware requirement) can support Windows 7/ Windows 8 / Windows 10.
2. Make sure your video card can run Windows 7/ Windows 8 / Windows 10.
3. If your video card can support Windows 7/ Windows 8 / Windows 10, need to install the latest Windows 7/ Windows 8 / Windows 10 driver of your video card.

Suggest to do the following:

1. Install the latest Windows 7/ Windows 8 / Windows 10 video driver of your video card.
2. Try to use the recommended display resolution that is supported by the monitor.
3. If the recommended display resolution is not working, try the second recommended display resolution.

	1	2
35,56cm / 14" (16:9)	1366×768@60Hz	1366×768@50Hz
39,6cm / 15.6" (16:9)	1366×768@60Hz	1366×768@75Hz
40,64cm / 16" (16:9)	1366×768@60Hz	1366×768@50Hz
43,2cm / 17" (16:10)	1440×900@60Hz	1440×900@75Hz
47cm / 18.5" (16:9)	1366×768@60Hz	1366×768@75Hz
48,3cm / 19" (5:4)	1280×1024@60Hz	1280×1024@75Hz
48,3cm / 19" (16:10)	1440×900@60Hz	1440×900@75Hz
51cm / 20" (16:9)	1600×900@60Hz	1600×900@50Hz
56cm / 22" (16:10)	1680×1050@60Hz	1680×1050@50Hz
54,6cm / 21.5" (16:9)	1920×1080@60Hz	1920×1080@50Hz
58,4cm / 23" (16:9)		
60cm / 23.6" (16:9)		
62,5cm / 24.6 (16:9)		
68,6cm / 27" (16:9)		
70cm / 27.5" (16:10)	1920×1200@60Hz	1920×1200@50Hz

And if you still have display problem after doing the above procedure, please visit Hannspree support and Service Website: <http://www.hannspree.eu/en/monitors>

Windows is a registered trademark of Microsoft Corporation.

ERROR MESSAGE & POSSIBLE SOLUTIONS

- **CABLE NOT CONNECTED:**
 1. Check that the signal-cable is properly connected, if the connector is loose, tighten the connector's screws.
 2. Check the signal-cable's connection pins for damage.

- **INPUT NOT SUPPORT :**
Your computer has been set to unsuitable display mode, set the computer to display mode given in the following table.

FACTORY PRESET TIMING TABLE:

MODE	RESOLUTION	HORIZONTAL FREQUENCY (KHz)	VERTICAL FREQUENCY (Hz)
1	640×400 @70Hz	31.469	70.087
2	640×480 @60Hz	31.469	59.940
3	640×480 @70Hz	36.052	70.004
4	640×480 @67Hz	35.000	66.667
5	640×480 @72Hz	37.861	72.809
6	640×480 @75Hz	37.500	75.000
7	720×400 @70Hz	31.469	70.087
8	800×600 @56Hz	35.156	56.250
9	800×600 @60Hz	37.879	60.317
10	800×600 @72Hz	48.077	72.188
11	800×600 @75Hz	46.875	75.000
12	832×624 @75Hz	49.725	75.000
13	1024×768 @60Hz	48.363	60.004
14	1024×768 @70Hz	56.476	70.069
15	1024×768 @75Hz	60.023	75.029
16	1152×870 @75Hz	68.681	75.062
17	1152×864 @75Hz	67.500	75.000
18	1280×720 @60Hz	45.000	60.000
19	1280×960 @60Hz	60.000	60.000
20	1280×960 @75Hz	74.592	74.443
21	1280×768 @60Hz	47.776	59.870
22	1280×768 @75Hz	60.289	74.893
23	1280×1024 @60Hz	63.981	60.020
24	1280×1024 @75Hz	79.976	75.025
25	1360×768 @60Hz	47.712	60.015
26	1366×768 @60Hz	47.852	59.964
27	1440×900 @60Hz	55.469	59.901
28	1440×900 @75Hz	70.635	74.984

29	1400×1050 @60Hz	64.744	59.948
30	1600×900 @60Hz	55.540	59.978
31	1680×1050 @60Hz	65.290	59.954
32	1920×1080 @60Hz	67.500	60.000

(Video mode)

MODE	RESOLUTION
1	640×480p @60Hz
2	720×480i @60Hz
3	720×480p @60Hz
4	720×576i @50Hz
5	720×576p @50Hz
6	1280×720p @60Hz
7	1920×1080i @50Hz
8	1920×1080i @60Hz
9	1920×1080p @50Hz
10	1920×1080p @60Hz

** We ensure that the monitor can be lighted under interlace signal mode, but we can not guarantee the image quality.

APPENDIX

SPECIFICATIONS

LCD Panel	Driving system	TFT Color LCD
	Size	39.62cm / 15.6" Diagonal
	Pixel pitch	0,17925mm(H) × 0,17925mm(V)
Video	H-Frequency	30KHz – 83KHz
	V-Frequency	56Hz – 75Hz
Display Colors		262K
Max. Resolution		1920 × 1080 @60Hz
Plug & Play		VESA DDC2B™
Power consumption	ON Mode	7W (Typical)
	Power Saving Mode	≤0.5W
	OFF Mode	≤0.3W
Audio output		Rated Power 1.0 W rms (Per channel)
Input Terminal		Type-C HDMI
Maximum Screen Size		Hor. : 344.16mm Ver. : 193.59mm
Power Source		100–240V 50–60Hz 5V~2.0A
Environmental Considerations		Operating Temp:5° to 35°C Storage Temp.: -20° to 60°C Operating Humidity: 20% to 80%
Dimensions		356.77 (W)×224.92(H)×10.1(D) mm 14.04 "(W)×8.85 "(H)×0.4 "(D)
Weight (N.W)		730g (1.6 lb)

*** The above specification is subject to actual product specification and is subject to change without prior notice.

NOTES:

The Maximum Resolution will depends on the display card supporting. Related issue can refer to <http://www.hannspree.eu/en/monitors>. FAQ section.